

**MEDIANA
HEARTON
AED A15**



OPERATOR'S MANUAL

HeartOn A15[®]

Automated External Defibrillator

www.medianadefib.co.uk

Distributed by:

Reliance Medical Limited

Congleton, Cheshire CW12 4XP

Part Number-Revision: A7300-0

Revised Date: 0613

Copyright © 2013 All rights reserved.

CE
0434

Directive

- Copyright law allows no part of this instruction manual to be reproduced without permission.
- The contents of this manual are subject to change without notice.
- The contents of this manual should be correct. If, for some reason, there are any questionable points, please do not hesitate to contact our service center.
- The manual will be replaced if any pages are missing or collation is incorrect.

Warranty

- Device failure or damage related to the following situations during the guarantee period is not covered by this warranty:
 - Installation, transfer installation, maintenance and repairs by any person other than an authorized Mediana employee or technician specified by Mediana.
 - Damage sustained to the Mediana product(s) caused by product(s) from another company excluding products delivered by Mediana.
 - Damage – caused by mishandling and/or misuse – is the responsibility of the user.
 - Maintenance and repairs utilizing maintenance components that are not specified by Mediana.
 - Device modifications or use of accessories not recommended by Mediana.
 - Damage caused by accidents or natural disasters (earthquakes, flooding, etc.).
 - Damage resulting from usage where caution statements and operating instructions shown in this manual have not been followed.
 - Damage due to neglect of specified maintenance checks.
- This warranty only covers the hardware of the HeartOn A15. The warranty does not cover the following selections:
 - Whatever damage or loss results from the attachment of accessories or their operation.
 - In the event of a defect in the product, contact our sales outlet or EU representative as noted on the back cover.
- The HeartOn A15 conforms to the EMC standard IEC60601-1-2.

Note: It is possible that using in the vicinity of mobile phone may result in disruption in the AED operation.

Revision History

The documentation part number and revision number indicate its current edition. The revision number changes when a new edition is printed in accordance with the revision history of the documentation. Minor corrections and updates which are incorporated at reprint do not cause the revision number to change. The document part number changes when extensive technical changes are incorporated.

Trademark

Product brand names shown in this manual are likely to be the trademark or registered trademark of the company concerned.

CONTENTS

CONTENTS	i
SAFETY INFORMATION	1
General Safety Information.....	1
Warning	1
Cautions	3
INTRODUCTION	5
Intended Use for the AED.....	5
About This Manual.....	5
Identifying the AED Configurations.....	5
DESCRIPTION OF THE AED	7
Top and Right Panel Components	7
Rear Panel Components	8
Symbols and Labels	9
SETTING UP THE AED	11
Unpacking and Inspection	11
List of Components.....	11
Soft Carry Case	12
SD card.....	12
Infrared communication port.....	12
Setting up the AED	13
Temperature status	13
BATTERY OPERATION	15
Operating the AED on Battery Power.....	15
Battery Status Indication.....	17
Self Test	18
USING THE AED	21
2010 AHA Guidelines for CPR and ECC.....	21
Major changes in the 2010 AHA Guidelines for CPR and ECC	21
Pre Defibrillation Action	23
Operating the AED	23
Operation of HeartOn A15.....	24
Operation of HeartOn A15-G4.....	27
AHA 2010 configuration.....	29
Note Performing CPR.....	29
Note User and Bystander Safety	29
MAINTENANCE	31
Recycling and Disposal	32
Returning the AED and System Components	32
Service.....	32
Periodic Safety Checks	32
Cleaning	33
Battery Maintenance.....	33
Pads Maintenance	33
The AED Maintenance	34
TROUBLESHOOTING	35
General.....	35
Corrective Action	35
EMI (Electromagnetic Interference).....	36
Obtaining Technical Assistance	37
GLOSSARY	39
SPECIFICATION	41
Compliance.....	46
Manufacturer's Declaration.....	49

Figures

<i>Figure 1. HeartOn A15: Top and Right Panel Components</i>	7
<i>Figure 2. HeartOn A15-G4: Top and Right Panel Components</i>	7
<i>Figure 3. Rear Panel Components</i>	8
<i>Figure 4. Replacing the handle/battery – Right Panel</i>	15
<i>Figure 5. Replacing the handle/battery – Upper Panel</i>	16
<i>Figure 6. Patient mode switch</i>	24
<i>Figure 7. HeartOn A15: Action Icon – Step 1</i>	24
<i>Figure 8. HeartOn A15: Action Icon – Step 2</i>	24
<i>Figure 9. HeartOn A15: Action Icon – Step 3</i>	25
<i>Figure 10. HeartOn A15: Action Icon – Step 4</i>	25
<i>Figure 11. HeartOn A15: Action Icon – Step 5</i>	25
<i>Figure 12. Pads Placement</i>	25
<i>Figure 13. HeartOn A15: Action Icon – Step 6</i>	26
<i>Figure 14. HeartOn A15: Action Icon – Step 7</i>	26
<i>Figure 15. HeartOn A15: Action Icon – Step 8</i>	26
<i>Figure 16. HeartOn A15-G4: Action icon – Step 1</i>	27
<i>Figure 17. Pads placement</i>	27
<i>Figure 18. HeartOn A15-G4: Pad disconnect icon</i>	27
<i>Figure 19. HeartOn A15-G4: Action icon – Step 2</i>	28
<i>Figure 20. HeartOn A15-G4: Action Icon – Step 3</i>	28
<i>Figure 21. HeartOn A15-G4: Action Icon – Step 4</i>	28
<i>Figure 22. Use by date of Pads</i>	34

Tables

<i>Table 1. Top and Right Panel Components</i>	8
<i>Table 2. Panel and Label Symbols</i>	9
<i>Table 3. Accessories</i>	11
<i>Table 4. The battery Status Icon</i>	17
<i>Table 5. Electromagnetic Emissions (IEC60601-1-2)</i>	49
<i>Table 6. Electromagnetic Immunity (IEC60601-1-2)</i>	49
<i>Table 7. Electromagnetic Immunity (IEC60601-1-2) (continued)</i>	50
<i>Table 8. Recommended Separation Distances</i>	51
<i>Table 9. Cables (IEC60601-1-2)</i>	51

SAFETY INFORMATION

General Safety Information

This section contains important safety information related to general use of the HeartOn A15[®]. Other important safety information appears throughout the manual. The HeartOn A15[®] will be referred to as the AED throughout this manual.

Before use, carefully read operator's manual, accessory directions for use, all precautionary information and specifications.

Warning



Warnings are identified by the **WARNING** symbol shown above.

Warnings alert you to potential serious outcomes (death, injury, or adverse events) to the patient or user.



WARNING: As a user of an AED it is essential that you inform Mediana of any incident where your AED is suspected to have caused a death, serious injury or illness. If you have any suspicions that this is the case inform Mediana directly or through your authorized Mediana dealer.



WARNING: The AED has the capability to deliver therapeutic electrical shocks. The shock can cause serious harm to either operators or bystanders. Caution must be taken to ensure that neither the operators nor bystanders touch the when a shock is to be delivered.



WARNING: The AED has not been evaluated or approved for use in hazardous locations as defined in the National Electrical Code (Articles 500-503). In accordance with the IEC/EN 60601-1 Classifications, the AED is not to be used in the presence of flammable substance/air mixtures.



WARNING: The AED has been designed to work on unresponsive, non-breathing and pulseless* patients. If the patient is conscious or breathing and regain a pulse, do not use the AED to provide treatment. (*checking pulse corresponds to health care provider)



WARNING: Touching the patient during the analysis phase of treatment can cause interference with the diagnostic process. Avoid contact with the patient and keep the patient as motionless as possible while ECG analysis is being carried out. The AED will instruct you when it is safe to touch the patient.



WARNING: Always stand clear of patient when delivering treatment. Defibrillation energy delivered to the patient may be conducted through the patient's body and cause a lethal chock to those touching the patient.



WARNING: It has been determined that the AED is safe to use in conjunction with oxygen mask delivery systems. However, due to the danger of explosion it is strongly advised that the AED should not be used in the vicinity of explosive gases. This includes flammable anesthetics, concentrated oxygen and gasoline.



WARNING: The identical pad is used for both Adult and Pediatric. The Adult mode must be used on patients over 8 years old. The Pediatric mode must be

used on patients less than 8 years old or less than 25 kg (55lb). Do not use the AED on patient less than 1 year old.



WARNING: Proper placement of the pads is critical. Strict observance of pad positioning instructions, as indicated on the labeling and in training, is essential. Care must be taken to ensure pads are adhered to the patients' skin properly. Air pockets between the adhesive pad and skin must be eliminated. Failure in pad adhesion may hinder effectiveness of therapy or cause excessive skin burns to the patient if a shock is applied. Reddening of the skin may appear after use, this is normal.



WARNING: The battery of AED is not rechargeable. Do not try to recharge, open, crush, or burn the battery, or it may explode or catch fire.



WARNING: Do not allow the pads to contact other electrodes or metal parts that are in contact with the patient. Such contact can cause patient skin burns during defibrillation and may divert defibrillating current away from the heart.



WARNING: Pay attention to possibility of contact with conduction part of electrode, lead line, cable connector, other patient installation part for patient safety.



WARNING: Do not use this unit near or within puddles of water.



WARNING: Do not reuse electrodes to many patients.



WARNING: Use the AED or accessories only as described in this manual. Improper use of the AED can cause death or injury.



WARNING: Do not use or place the AED in service if the status indicator of AED displays "X".



WARNING: Keep batteries dry and away from any heat sources (including direct sunlight). If you see any damage or leakage, do not allow the liquid to come in contact with your skin or eyes. If contact has been made, wash the affected area with plenty of water and seek medical advice immediately.



WARNING: The AED contains an automatic disarm of the stored energy. If the operator has not delivered the energy to a patient, an internal timer will disarm the stored energy. This stored electrical energy can potentially cause death or injury if discharged improperly. Follow all instructions in this manual.

Cautions



Cautions are identified by the CAUTION symbol shown above.

Caution statements identify conditions or practices that could result in damage to the equipment or other property.



CAUTION: The AED may not operate properly if it is operated or stored at conditions outside the ranges stated in this manual.



CAUTION: The AED was designed to be sturdy and reliable for many different use conditions. However, handling the AED too roughly can damage it or its accessories and will invalidate the warranty. Check the AED and accessories regularly for damage, according to directions.



CAUTION: Before delivering a shock, it is important to disconnect the patient from non-defibrillation protected electronic devices, such as blood-flow meters, that may not incorporate defibrillation protection. In addition, make sure the pads are not in contact with metal objects such as a bed frame or stretcher.



CAUTION: The pads pouch shall not be opened until immediately prior to use.



CAUTION: Do not use or place the AED in service until you have read the AED Operator's manual.



CAUTION: Do not use or stack the AED with other equipment. If the AED is used or stacked with other equipment, verify proper operation prior to use.



CAUTION: Handling or transporting the patient during ECG analysis can cause incorrect or delayed diagnosis. If the AED gives a SHOCK ADVISED prompt during such handling or transport, stop the vehicle and keep the patient as still as possible for at least 15 seconds before pressing the Shock button, to allow the AED to reconfirm the rhythm analysis.



CAUTION: Periodic checks of this AED must be undertaken to ensure among other things that the AED is not damaged in any way.



CAUTION: The pads are a single use item and must be replaced after each use or if pouch that seals pads has been broken/compromised in any way. If damage is suspected the pads must be replaced immediately.



CAUTION: Do not use training pads with this AED.



CAUTION: Carefully observe pacemaker patients. Patient history and physical examination are important in determining the presence of implanted pacemaker. Patient pacemakers may reduce the sensitivity of the AED analysis and errors in detecting shockable rhythms.



CAUTION: If the pads are attached to the chest firmly, the AED can analyze the exact ECG and prevent the skin burns. But if the pads are overlapped on the patient chest, the pads will not deliver defibrillation energy properly.

INTRODUCTION

Mediana provides you with a fully configurable AED system to allow you to comply with your chosen SCA treatment protocol. Our current AED is configured to be compliant with the 2010 version of the AHA/ERC guidelines on Cardiopulmonary Resuscitation (CPR) and Emergency Cardiovascular Care (ECC). You should have been trained in the appropriate version of the AHA/ERC guidelines and the use of your AED configuration. Contact Mediana or your authorized Mediana distributor for further information.

Intended Use for the AED

The AED is intended to be used to treat someone who is unresponsive, non-breathing and pulseless for the adult and pediatric in all area of a hospital, pre-hospital, public access and alternate care. AED users should be skilled at level of a doctor, nurse, medical specialist trained user.

Note: Hospital use typically includes areas such as general care floors, operating rooms, special procedure areas, intensive and critical care areas within the hospital. Hospital-type facilities include physician office-based facilities, sleep labs, skilled nursing facilities, surgical centers, and sub-acute care centers.

Note: The intended patient populations are adult and pediatric (1-8 years old or less than 25 kg (55lb)) can be treated with the appropriate mode.

Note: The AED is intended for trained user who knows how to use the AED. Potential user should be trained in cardiopulmonary resuscitation (CPR), the use of the AED. Many training institutes have courses that combine performing CPR and using the AED. The training course can be accomplished for various durations, but crash course/most basic course can be accomplished in one day. For further information on training course, contact your local authorized supplier or Mediana technical support.

About This Manual

This manual explains how to set up and use the AED.

Read the entire manual including the *Safety Information* section, before you operate the AED.

Identifying the AED Configurations

The following table identifies the AED configurations and how they are indicated. The Reference number and serial number are located on the bottom of the AED.

Configuration	Reference No.	Description
HeartOn A15	A15M-G8-0(E)	AED Standard (8 Action Icons)
HeartOn A15-G4	A15M-G4-0(E)	AED Standard (4 Action Icons)

Note: The alphabet "E" can be added as the last digit of reference number in accordance with the region.

Training

SCA is a condition requiring immediate emergency medical intervention. This intervention, due to the nature of the condition, can be performed prior to seeking the advice of a physician. In order to properly diagnose this condition Mediana recommends that all potential users of the AED as a minimum, are fully trained in cardiopulmonary resuscitation (CPR), the use of the AED, specifically the AED. It is also recommended that this training be kept up to date by means of regular refresher courses and when recommended by your training provider. If potential users of the AED are not trained in these techniques contact your Mediana dealer or Mediana directly either of whom can arrange for training to be provided. Alternatively contact your local government health department for information on certified training organizations in your region.

Note: There is limited published data on AED used by minimally trained rescuers in the home. It is not clear what safety issues may occur from AED use in such an environment.

Features for the AED

Physical/Mechanical

The AED is an automated external defibrillator (AED) used for the fast delivery of defibrillation electric shock therapy which can be battery-operated.

Electrical

The AED has an internal battery which is the non-rechargeable battery.

Display

The indication is LED indicator that flashes red LED under the relevant action icon.

Auxiliary Input/Output(s)

The AED provides Infrared communication port, SD card ports.

DESCRIPTION OF THE AED

Top and Right Panel Components

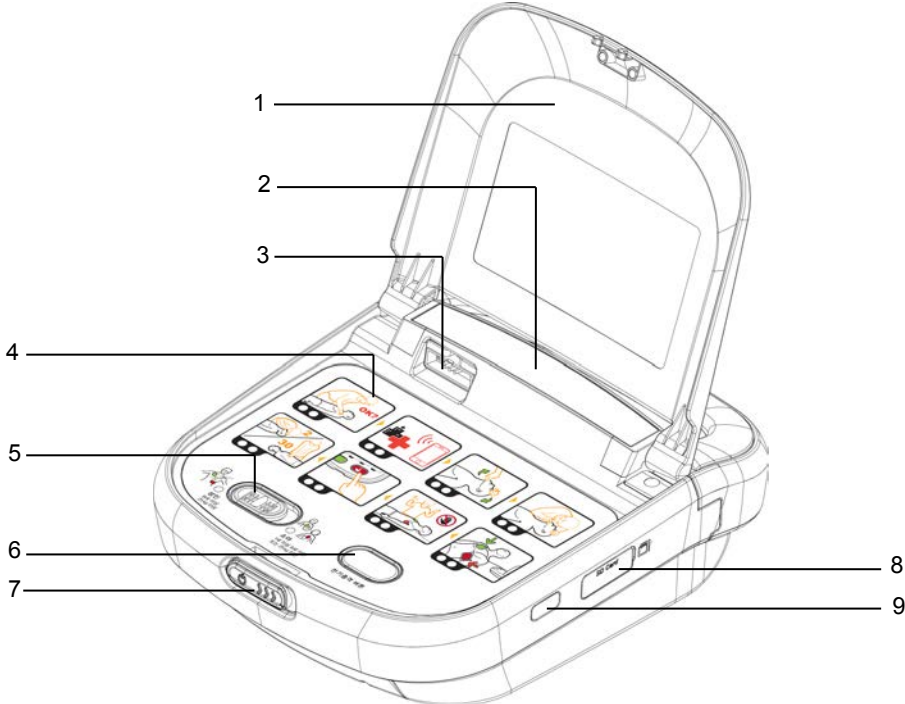

Figure 1. HeartOn A15: Top and Right Panel Components

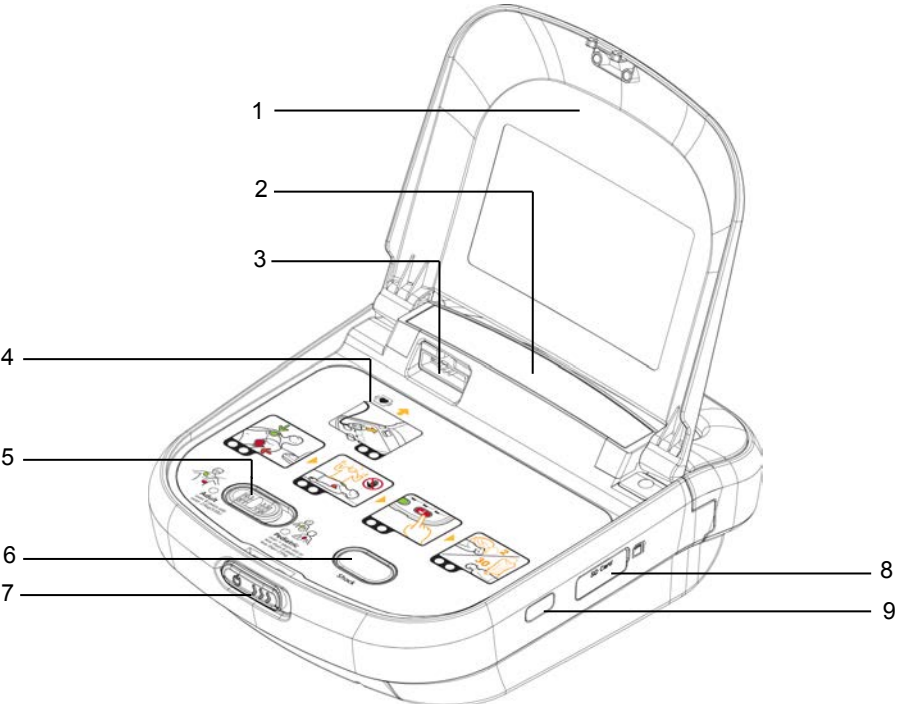

Figure 2. HeartOn A15-G4: Top and Right Panel Components

Table 1. Top and Right Panel Components

1 Cover	Cover is used to protect the action icon, the patient mode switch, the chock button.
2 Status indicator	Status indicator displays the unit status, the temperature status and the battery status.
3 Pad connector	Pad connector links the pads.
4 Action icon	LED indicator flashes red LED under the relevant action icon.
5 Patient mode switch	After user distinguish the patient according to patient type, select the patient mode between adult and pediatric patient mode by pushing the patient mode switch.
6 Shock button	When preparation for electric shock is completed, the shock button will flash. Push the Shock button and then the AED delivers the shock.
7 Slide button	Slide button is used to open the cover and turn on by pushing the slide button to right.
8 SD card port	SD card is used to save the data and update the AED firmware.
9 Infrared communication port	Infrared communication port is used to communicate with the PC.

Rear Panel Components



- 1 _____
- 2 _____















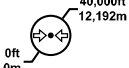
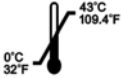

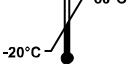
1. Handle/Battery
2. Battery detachable button

Figure 3. Rear Panel Components

Symbols and Labels

The following symbols may be used in this manual, related documentation, or appear on system components or packaging.

Table 2. Panel and Label Symbols

Symbols	Description	Symbols	Description
	Ready to use		Attention, consult accompanying documents
	Not ready to use		CE mark
	Battery status		Environmental shipping/storage altitude limitations
	Temperature status		Environmental shipping/storage humidity limitations
	Contains no latex		Environmental shipping/storage temperature limitations
	Use by date		Fragile-handle with care
	Consult instruction for use		This way up
	Manufacturer		Keep dry
	Date of manufacture		Type CF – Defibrillator proof
REF	Reference number	IP54	Dust and water resistance
SN	Serial number		Single patient use only
	Disposal instructions		

SETTING UP THE AED



WARNING: To ensure accurate performance and prevent AED failure, do not expose the AED to extreme moisture, including direct exposure to rain. Such exposure may cause inaccurate performance or AED failure. Refer to Specification section.



WARNING: Using damaged or expired AED or accessories may cause the AED to perform improperly, and/or injury the patient or the user.

Unpacking and Inspection

The AED is shipped in one carton. Examine the AED including the accessories carefully for evidence of damage. Do not use damaged equipment. Refer to the Maintenance section for instructions on returning damaged items. Ensure all potential users are suitably trained.

Note: Inspect the packaging of accessories to ensure integrity of seals and validity of use by date.

List of Components

The following items are accessories in the package. Optional accessories may be ordered if needed. Contact qualified service personnel or your local supplier for pricing and ordering information.

Table 3. Accessories

Standard Accessories	Qty
HeartOn A15 [®]	1
HeartOn A15-G4 [®]	
Operator's manual	1
Adult/Pediatric Pads (1.8m)	1
Non-rechargeable LiMnO ₂ Battery (15V, 4200mAh)	1
Soft Carry Case	1
Optional Accessories	Qty
SD card (2Gbyte)	-
HeartOn AED Event Review Software	-
HeartOn AED Event Review Software - User Guide	-
Infrared communication adaptor	-
Recommended Accessories	Qty
Scissors – for cutting the victim's clothed if needed	-
Disposable gloves – to protect the user	-
A disposable razor- to shave the chest if hair prevents good pads contact	-
A pocket mask or face shield – to protect the user	-
A towel or absorbent wipes - to dry the victim's skin for good pads contact	-

Soft Carry Case



WARNING: The AED should not be used on someone who is responsive when shaken or breathing normally.

The soft carry case has been designed to allow the AED not to move in the soft carry case by using the AED own handle. The user can check the status indicator of AED without having to open the carry case. The paper with contact information of the nearest emergency medical services can be inserted to the clear cover. The soft carry case has the pocket on the rear side of the carry case for the manual and spare pads. Other two pockets on the right and left side of the carry case are used for spare battery.

SD card

The SD card is inserted into the SD card port on the AED's right panel as described below. The SD card is used to record the history of the AED performance and to update the AED firmware. The recorded history in the SD card can be checked by the HeartOn AED Event Review Software. If you want to use the SD card to use the HeartOn AED Event Review Software or to update the AED firmware, please contact qualified service personnel or your local supplier.

1. When the AED is turned on, turn off the AED by closing the cover.
2. Open the SD card port cover.
3. Insert the SD card into the SD card port.
4. Close the SD card port cover.
5. If necessary to update the AED through SD card, turn on the AED by pushing **Slide button** to the right.
6. After complete the update, automatically turn off itself. Close the cover again.

Infrared communication port

Infrared communication port provides wireless communications from the AED to a PC through the Infrared communication data download cable and DC adaptor which is connected to PC. The Infrared communication is used to update the AED firmware and to transfer information and to connect to service mode. If you want to use Infrared communication port, please contact qualified service personnel or your local supplier.

Setting up the AED



WARNING: Use only Mediana-approved and specified parts, accessories, optional parts, consumables, and components. Use of unauthorized accessories may cause the device to operate improperly and provide false measurements. Follow all labeling instructions on the defibrillation pads and the battery.



WARNING: Always follow your facility's infection control procedures and applicable regulations when disposing of anything that has been used on patients.



CAUTION: Do not open the pads from packaging previously until the time of emergency use when pads are used for patient.

Temperature status

Temperature status displays the following description.

- If the self test is implemented in out-of range for environmental operation condition above 5 times, the status indicator 'X' will be displayed.
- When the AED with displaying status indicator 'O' is turned on in out-of-range for environmental operation condition.

Note: When the AED with displaying status indicator 'X' and temperature status is turned on in specified environmental operation condition, will operate properly.

Note: When the AED is turned on in the inappropriate environmental operation condition, temperature status will be blink.

Note: If the AED is placed in out-of-range value for environmental operation condition for long time, it will be longer than usual to recognize the temperature. It is recommended that AED should be stored in environmental operation condition described in this manual.

Install 1

1. Install the battery to the AED.
2. The status indicator of the AED will display "X" and then operate the battery insertion self test.
3. When the battery insertion self test is completed normally, voice prompt "Unit ok" will be emitted and the status indicator will be changed from "X" to "O".
4. Take out the pads from the packaging.
5. To open the cover, push the **Slide button** to the right.
6. Plug in defibrillation pads.
7. To turn off, close the cover of the AED.

Note: When pads are already connected to the AED in packaging, take out the AED from the packaging and then move to Install 2.

Note: The pads should be connected to the AED as preparation for emergency circumstances.

Note: Do not open defibrillation pads protective packaging until the time of emergency use when they are applied to a patient.

Install 2

Check that the AED is working optimally.

1. Change the Patient mode switch by pushing Slide button to the right or left for distinguish between adult and pediatric,
2. Turn on the AED by pushing **Slide button** to the right and opening the cover, ensure that you can hear the voice prompt.
 - “Unit ok”
 - “Adult pads” or “Pediatric pads”
3. Ensure you can see the status indicator displays “O”.
4. Turn off the AED by closing the cover.
5. Close the Cover with placing the defibrillation pads inside the AED.

Note: When the battery is replaced with the AED, self test will be automatically started. After completing the self test, ensure that you can hear the voice prompt “Unit ok” and then check the AED is turned off.

Install 3

Place the AED into its Soft Carry Case.

Install 4

Put into a storage or safe visible location.

Note: Storage differs in some countries. Ask qualified service personnel or your local supplier.

The AED should be kept in a convenient central area. Place it near a telephone so that the rescuer can call Emergency Medical Services and retrieve the AED without wasting time. Some important points to remember when storing:

- Store the AED in a suitable location for easy access.
- Do not lock the location where the AED is being placed.
- Store the AED in a clean and dry environment.
- Install the AED in the environmental operation condition described in this manual.







Make all necessary arrangements to ensure that the AED is accessible at all times. Inform any possible users of the location of the AED.

BATTERY OPERATION

-  **WARNING:** Test battery regularly, when the voltage of battery is very low. A battery that does not pass its test might shut down expectedly.

-  **WARNING:** Do not use a battery that is damaged, leaking, or wet.

-  **WARNING:** Do not use or store the battery in a place that may be exposed to high temperature.

-  **CAUTION:** To ensure the availability of adequate power during an emergency, keep a fully charged spare battery pack with the AED at all times.
-  **CAUTION:** When the voltage of the battery is very low, it is a possibility of not operating.
-  **CAUTION:** If the battery shows any signs of damage, leakage or cracking, it must be replaced immediately.
-  **CAUTION:** Discarded batteries may explode during incineration. Dispose used batteries properly. Do not dispose of batteries in refuse containers.
-  **CAUTION:** Check battery capacity regularly. Replace the new battery if you need.
-  **CAUTION:** Except for inspection, if the AED is frequently turned on, turned off or discharged, battery standby life will not last longer than the intended standby life by manufacturer.

Operating the AED on Battery Power

The AED has an installed non-rechargeable battery. The battery status appears on the status indicator when the AED is on battery power. The battery of AED is the handle part and replace the new handle/battery if need arises.

Replacing the battery

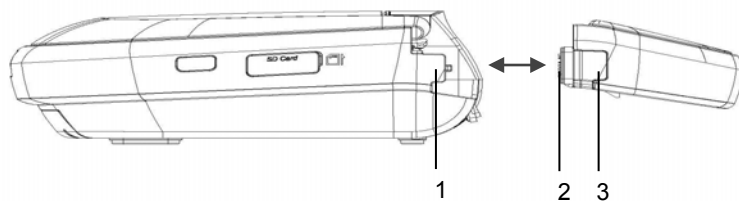

1. Handle/Battery connector
2. AED connector
3. Handle/Battery detachable button

Figure 4. Replacing the handle/battery – Right Panel

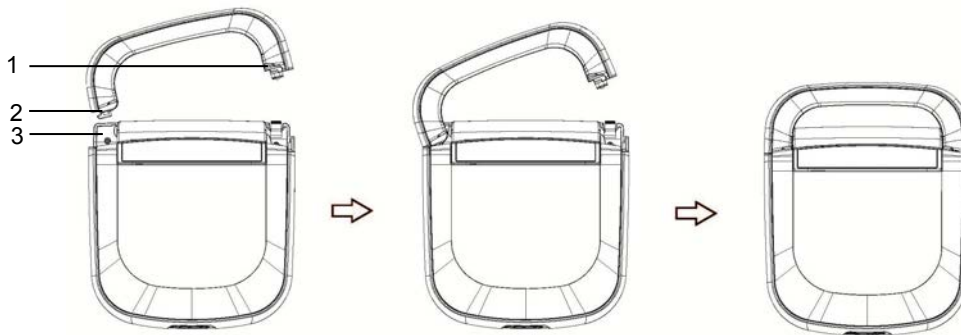

1. AED connector
2. Hook
3. Handle/Battery connector

Figure 5. Replacing the handle/battery – Upper Panel

1. Pull up while pushing the handle/battery detachable button, then disconnect the handle/battery.
2. Tilt up the handle/battery and then keep the handle/battery detachable button and AED connector perpendicular as shown in the Figure 4.
3. Connect the AED and handle/battery by using the hook as shown in the first figure of the Figure 5.
4. With the handle/battery being connected to the AED by hook, connect handle/battery connector and hook of the AED as shown in the second figure of the Figure 5.
5. When the both of the connection parts are fastened properly, the clink sound will be emitted.

The AED uses the non-rechargeable battery. Used battery is changed to new battery. Before turning on the AED with a battery that has been completely discharged, first replace the battery. When the new battery is installed, the AED is automatically turned on and then starts the battery insertion self test. After the battery insertion self test is completed, the AED may then be powered off.

Battery Status Indication

A new battery's life time is as below;

- Shelf life (in the original packaging): 2 years from manufacture date when stored and maintained according to direction provided in the operator's manual.
- Standby life (inserted in the AED): 5 years from manufacture date when stored and maintained according to direction provided in the operator's manual.
- Discharge: A minimum of 200 shocks (excepting the CPR period between the defibrillation therapies) or 10 hours of operating time under the ambient temperature at 20 °C.





Mediana recommends that although the battery is used only one time, used battery is changed to new battery.

Note: After 200 times of shock, the voice prompt "Low battery, replace new battery" will be emitted.

Note: Due to the physical dimensions of the battery compartment, only batteries supplied by Mediana should be used. Using other types of replacement batteries may result in damage to the AED and void the limited warranty.

When operating on batteries, the battery status in the status indicator indicates the battery condition. See Table 4.

Table 4. The battery Status Icon

Battery Status Icons	Battery Status
	full charged (\leq 200 shocks or 10 hours of operating time)
	used
	used (\leq 9 shocks)
	discharged (no shock)

If you hear the voice prompt "low battery, replace new battery" when the AED is turned on or is being used, the AED would be available 9 shocks. If the last bar of the battery indicator is invisible, buzzer would be sounded 2 times and then turned off automatically.

Self Test

Before using the AED, confirm that the AED is working properly and is safe to use as described below.



WARNING: If the self test is not completed successfully, do not try to use the AED.



CAUTION: When power is applied, the AED automatically starts the self test, which tests the AED circuitry and functions. During performing Power On Self Test(POST), confirm that the AED status indicator turns on. If the AED status indicator does not function properly, do not use the AED. Instead, contact qualified service personnel or your local supplier.

Performing Power On Self Test (POST)

1. Turn on the AED by pushing the **Slide button**.
2. The AED automatically starts the Power On Self Test (POST).
3. If the AED detects an error during POST, the status indicator will display “X”. Contact qualified service personnel or your local supplier for assistance.
4. Upon successful completion of the POST, the AED sounds voice prompt “Unit ok” and the status indicator displays “O”.
5. Turn off the AED by closing the cover.

Automatic Self Test

The AED includes an automatic self test which is performed on a daily basis. The self test will run automatically and requires no user interaction. If there is an error, the status indicator displays “X”.

The self test will test your AED and ascertain if its basic functions are running.

- Daily self test : MCU and Memory(RAM, ROM) integrity, Battery capacity, ECG algorithm.
- Weekly self test : Waveform delivery circuit low (2J) energy test, ECG circuit test in addition to the daily self test.
- Monthly self test : Waveform delivery circuit high (50J) energy test in addition to the weekly self test.

Note: When the battery is discharged, the status indicator will display “X”. Even if the new battery is replaced, the status indicator still displays “X”. Please contact qualified service personnel or your local supplier.

Note: Self test is not able to determine if the battery and the pads currently inserted in the AED are within their use by date. You must remember to check the use by date on the pads and standby life on the battery regularly.

Battery Insertion Self test

When the battery is installed or replaced, the AED automatically starts the battery insertion self test. After battery insertion self test is completed, the AED sounds voice prompt “Unit ok”, the status indicator displays “O” and power of the AED is automatically turned off. If the battery insertion self test is not completed successfully, the AED sounds voice prompt “Unit fail” and the status indicator displays “X”. If the AED does not function properly, do not use the AED. Instead, contact qualified service personnel or your local supplier.

You can also skip the battery insertion self test, try following procedure

- Closed: skip by opening the cover.
- Opened: skip by pressing the shock button.

After finishing this procedure, the AED will perform the power on self test as when user turns on the AED.

Note: Self test is not able to determine if the battery and the pads currently inserted in the AED are within their use by date. You must remember to check the use by date on the pads and standby life on the battery regularly.

USING THE AED



WARNING: The AED should not be used on someone who is responsive when shaken or breathing normally.



WARNING: Do not use the pads if the pad gel is dried or damaged.



WARNING: Disconnect non-defibrillation protected electronic devices or equipment from patient before defibrillation.



WARNING: Never lift the AED by the pads cable or any other accessory. Such accessories could detach, causing the AED to fall on the patient.



CAUTION: Prolonged or aggressive CPR to a patient with pads attached can damage the pads. Replace the pads if they are damaged during use or handling.

The AED is designed for the treatment of sudden cardiac arrest (SCA). It should only be used to treat someone who may be a victim of a SCA and is:

- Unresponsive,
- Non-breathing,
- Pulseless, (health care provider only)

If the person is unresponsive but you are unsure that they have suffered from a SCA begin CPR. When appropriate apply the AED and follow the voice prompts.

2010 AHA Guidelines for CPR and ECC

The 2010 AHA Guidelines for CPR and ECC are based on the most current and comprehensive review of resuscitation literature ever published, the 2010 ILCOR International Consensus on CPR and ECC Science with Treatment Recommendations. Bystanders, first responders and healthcare providers all play key roles in providing CPR for victims of cardiac arrest. In addition, advanced providers can provide excellent periarrest and postarrest care.

Major changes in the 2010 AHA Guidelines for CPR and ECC

- The BLS algorithm has been simplified, and “Look, Listen and Feel” has been removed from the algorithm. Performance of these steps is inconsistent and time consuming. (The use for non-healthcare provider)
- Encourage Hands-only (compression only) CPR for the untrained lay rescuer. Hands-Only CPR is easier to perform by those with no training and can be more readily guided by dispatchers over the telephone.
- Initiate chest compressions before giving rescue breaths. (Compression-Airway-Breathing rather than Airway-Breathing-Chest compressions)
- There is an increased focus on methods to ensure that high-quality CPR is performed. The following action put emphasis on the important factor of high-quality CPR.
 - Adequate chest compressions (100 ~ 120/min)
 - Compression depth of at least 2 inches (5 cm) in adults
 - Allowing complete recoil of the chest after each compression
 - Minimizing any pauses in compressions
 - Avoiding excessive ventilation

2010 CPR GUIDELINES

This "Guidelines Highlights" publication summarizes the 2010 American Heart Association (AHA) Guidelines for Cardiopulmonary Resuscitation (CPR) and Emergency Cardiovascular Care (ECC) by American heart association and European emergency association. This is easy reference material for both lay rescuer and healthcare provider. Before installing the AED, it is recommended that the expected AED user should be trained to provide CPR and use the AED.

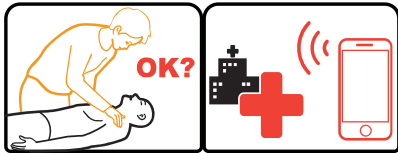

After call for help, get the AED.

Person not responsive?
No signs of life?

Address person and shake on shoulder!

Engage other people to help you and alternate CPR!



Open the airway, Check for breathing.
If the user is not a healthcare provider, the sequence for assessment of breathing after opening the airway might be eliminated.

Open the airway.
Check for breathing!

Note: "Open the airway, check for breathing" is removed from the CPR sequence for assessment of breathing after opening the airway in 2010 guidelines. But 2010 guideline recommends that the healthcare provider briefly checks for breathing when checking responsiveness to detect signs of cardiac arrest.

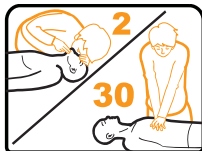

30 Compressions 2 Breaths
UNTIL EMC ARRIVE 30/2.

Perform CPR until an AED is available or arrival of emergency physician.

Note: Elimination of "2 ventilations" from sequence makes recommendations to continue the chest compressions.

If the AED available, turn on and follow instructions.

Repeat every 2 minutes.

ANALYSIS SHOCK DECISION

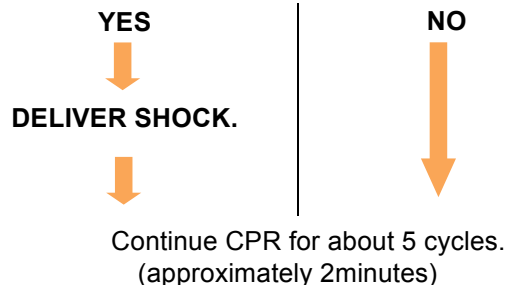

Pre Defibrillation Action

Prior to using the AED, it is advised to perform the following checks and actions in order to prepare the patient.

- Remove clothes to expose bare chest.
- If excessively hairy shave hair from areas to which defibrillation pads are to be applied.
- Ensure that the patient chest is dry. If necessary, dry chest area.

Operating the AED



WARNING: The Pediatric mode must be used on patients between 1-8 years old or less than 25 kg (55lb).



WARNING: If the pads placement is inappropriate, the AED could harm the patient. To place the accurate position, must follow the voice prompt and action icon. When pads placement is inappropriate, treatment could not work or shock could burn the patient's skin.



WARNING: Do not place pads near the generator of an internal pacemaker. The analyzing heart rhythm of patient who is implanted pacemaker could inaccurate or the pacemaker might be damaged by defibrillator discharges.



WARNING: Do not perform chest compressions (CPR) through electrodes. These actions may damage the electrode pads cause the AED to function improperly.



WARNING: Always apply pads to flat areas of skin. Avoid application over folds of skin such as those underneath the breast or on obese patients. Excessive hair, poor adhesion, or air under pads may produce burns or ineffective energy transfer.



WARNING: To apply the pads to patient chest properly, shave hair from areas which defibrillation pads are to be applied if necessary.



WARNING: Always check the use by date on the pads and do not use the pads if the packaging has been previously opened. The AED may interpret excessively dry pads as an attached pads cable.



WARNING: Touching the patient during the analysis phase of treatment can cause interference with the diagnostic process. Avoid contact with the patient while analysis is being carried out. The AED will instruct you by voice prompt when it is safe to touch the patient.



WARNING: The AED delivers shocks which can cause serious harm to operators and bystanders. Caution must be taken to ensure no-one is in contact with the patient when a shock is delivered.

Note: Only pads supplied by Mediana should be used. Using other types of pads may result in damage to the patient and the AED.

Note: If the AED is turned on in out-of-range of environmental operation condition described in this manual, temperature status will be blinked. In this case, place the AED in appropriate temperature before use it.

1. Check the status indicator displays "O".
2. To open the cover, push the **Slide button** to the right.

3. Turn on the AED by opening the cover.
4. The AED automatically starts the Power-On-Self Test.
5. The test result is displayed on the status indicator and the voice prompt sounds.
 - Self test is passed : Voice prompt “Unit ok”, Status indicator “O”
 - Self test is failed : Voice prompt “Unit failed”, Status indicator ”X”
6. If the pads is inserted and the Patient mode switch is selected, you will hear the voice prompt.:
 - Patient mode switch is switched to left, “Adult pads”
 - Patient mode switch is switched to right, “Pediatric pads”

If the pad is not inserted, you will hear the voice prompt:

- “Plug in pads. Insert connector firmly.”

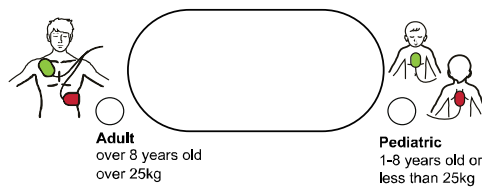

Figure 6. Patient mode switch

Note: The patient mode can switch even if which step is going on progress. If the patient mode is changed, the AED will emit the voice prompt “Adult pads” or “Pediatric pads”. However, the AED will not emit the voice prompt while analyzing ECG or delivering electric shock, even though the patient mode is changed during process.

7. Verify the AED up to ‘6.’ which is activated normally and follow voice prompt and action icon. The red LED will flash under the relevant action icon.

Operation of HeartOn A15

Step 1

- “Check for response. Are you all right?”



Figure 7. HeartOn A15: Action Icon – Step 1

Step 2

- “Call for help.”



Figure 8. HeartOn A15: Action Icon – Step 2

Step 3

- “Open the airway.”

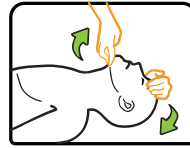

Figure 9. HeartOn A15: Action Icon – Step 3

Step 4

- “Check breathing.”



Figure 10. HeartOn A15: Action Icon – Step 4

Step 5

Remove clothes to expose the patient's chest. If the patient has an excessively hairy chest, shave the area where the pads are about to be applied.

- “Remove clothes from the patient's chest. Place pads exactly as shown in the picture. Press pads firmly to patient's bare chest.”

When pads are disconnected to the AED, the following voice prompt will be emitted.:

- “Plug in pads. Insert connector firmly.”

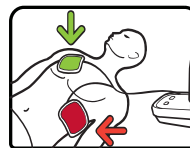
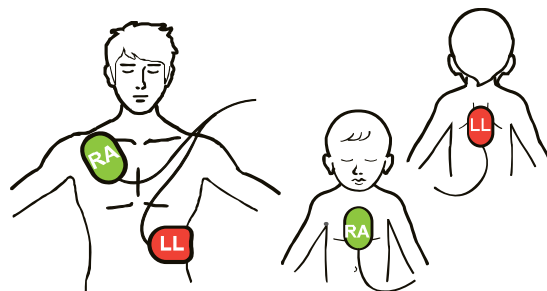

Figure 11. HeartOn A15: Action Icon – Step 5



Adult: age \geq 8, weigh \geq 25kg(55lbs)

Pediatric: age $<$ 8, weigh $<$ 25kg(55lbs)

Figure 12. Pads Placement



WARNING: Apply freshly opened and undamaged pads, within use by date, to clean and dry skin to minimize burning.

Step 6

When the pads are attached correctly to the patient you will hear the voice prompts:

- “Analyzing heart rhythm. Do not touch the patient.”
- “Shock advised. Charging. Do not touch the patient.”
- or
- “Analyzing heart rhythm. Do not touch the patient.”
- “No shock advised.”



Figure 13. HeartOn A15: Action Icon – Step 6

Note: If “No shock advised”, the AED will move to step 8 which demonstrate CPR progress directly.

Note: The AED performs the Step 6 directly when it is turned on after the rescuer attaches the pads to the patient properly. Also, the Step 6 would be started if the pads are attached to the patient even if the AED is under the Step 1 to 5. This can reduce the preparing time for electric shock in case of trained rescuer.

Note: Follow voice prompt. Do not touch patient or allow any others to touch the patient while the AED is analyzing. After completion of analysis, the AED will advise you of treatment recommended. Care must be taken to keep the patient still. A moving patient can lead to incorrect, delayed or less effective diagnosis and therapy.

Step 7

- “Press the shock button now. Deliver shock now”
- “Shock delivered.” or “Shock button not pressed.”

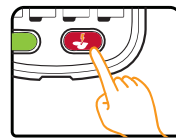

Figure 14. HeartOn A15: Action Icon – Step 7

Note: The AED will only administer a shock if it is needed. A voice prompt will tell you when to press the shock button to administer defibrillation therapy.

Step 8

- “It is safe to touch the patient.”
- “Begin CPR.” [Beep] or “If needed, Begin CPR.” [Beep]
- “Give two breaths.”
- “2 ~3, 5times repeat.”
- “Stop CPR.”

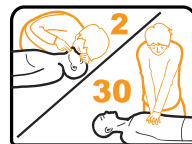

Figure 15. HeartOn A15: Action Icon – Step 8

Note: After finished the STEP8, the AED will move to the STEP 6 to analyze heart rhythm again.

Note: If you hear following voice prompt while the AED is analyzing you should perform the following actions:

- Rhythm changed, “Shock cancelled.”:
Move to Step 8. → Perform the CPR.
- “Shock button not pressed.” or “Disarms.”:
Move to Step 6. → ECG analyzing again. → non-shockable rhythm. → Move to

Step 8.

or

Move to Step 6. → ECG analyzing again. → shockable rhythm. → Move to Step 7.
→ Move to Step 8 after disarm.

- “Low battery, replace new battery.”:
Move to Step 1 after replace the new battery and complete the power on self test.

Operation of HeartOn A15-G4

Step 1

Remove clothes to expose the patient's chest. If the patient has an excessively hairy chest, shave the area where the pads are about to be applied.

- “Remove clothes from the patient's chest. Place pads exactly as shown in the picture. Press pads firmly to patient's bare chest.”

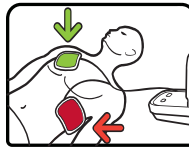

Figure 16. HeartOn A15-G4: Action icon – Step 1

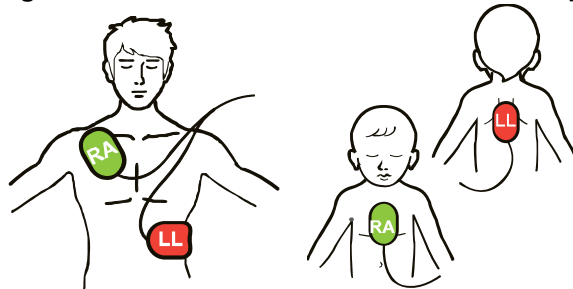

Figure 17. Pads placement

When the pads are not connected, the following voice prompt will be emitted.

- “Plug in pads. Insert connector firmly.”

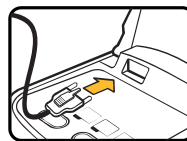

Figure 18. HeartOn A15-G4: Pad disconnect icon

Note: If the pad connector is not connected in any step, the AED will move to Pad connector disconnected icon and the voice prompt “Plug in pads. Insert connector firmly.” is emitted.

Step 2

When the pads, as shown in the figure 17 are attached correctly to the patient you will hear the voice prompts:

- “Analyzing heart rhythm. Do not touch the patient.”
 - “Shock advised. Charging. Do not touch the patient.”
- or
- “Analyzing heart rhythm. Do not touch the patient.”
 - “No shock advised.”



Figure 19. HeartOn A15-G4: Action icon –Step2

Note: If “No shock advised” voice prompt is emitted, the AED will move to step 4 which demonstrate the CPR progress.

Note: The AED performs the Step 2 directly when it is turned on after the rescuer attaches the pads to the patient properly. Also, the Step 2 would be started if the pads are attached to the patient even if the AED is under the Step 1. This can reduce the preparing time for electric shock in case of trained rescuer.

Note: Follow voice prompt. Do not touch patient or allow any others to touch the patient while the AED is analyzing. After completion of analysis, the AED will advise you of treatment recommended. Care must be taken to keep the patient still. A moving patient can lead to incorrect, delayed or less effective diagnosis and therapy.

Step 3

- “Press the shock button now. Deliver shock now.”
- “Shock delivered.” or “Shock button not pressed.”

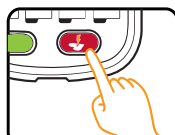

Figure 20. HeartOn A15-G4: Action Icon – Step 3

Note: The AED will only administer a shock if it is needed. A voice prompt will tell you when to press the shock button to administer defibrillation therapy.

Step 4

- “It is safe to touch the patient.”
- “Begin CPR.” or “If needed, Begin CPR.”
- “Give two breaths.”
- “2 ~3, 5times repeat.”
- “Stop CPR.”

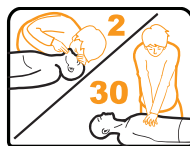

Figure 21. HeartOn A15-G4: Action Icon – Step 4

Note: If you hear following voice prompt while the AED is analyzing you should perform the following actions.

-
- Rhythm changed, “Shock cancelled.”:
Move to Step 4. → Perform the CPR.
 - “Shock button not pressed.” or “Disarms.”:
Move to Step 2. → ECG analyzing again. → non-shockable rhythm. → Move to Step 4.
or
Move to Step 2. → ECG analyzing again. → shockable rhythm. → Move to Step 3.
→ Move to Step 4 after disarm.
 - “Low battery, replace new battery.”:
User replaces the new battery, turn on by opening the cover. After complete the power on self test, use the equipment according to each step instruction.

AHA 2010 configuration

After the electric shock is delivered, the following voice prompt would be emitted.

- “It is safe to touch the patient.”
- “Begin CPR.”

Use the metronome sound from the AED for compression rate – the unit emits a tone corresponding at least more than 100 beats per minute (to current AHA guidelines). Note too that the “Begin CPR.” icon flashes at the same rate for additional guidance. At this point, adequate chest compressions require that compressions be provided at the compression depth of at least 2 inches (5 cm) in adults.

Rescuer performs 5 cycles of CPR, each cycle include 30 times of chest compression and 2 times of rescue breath at the rate of 30times of chest compression/2min. Or perform the chest compression without rescue breath. The AED will remain in CPR mode for 2 minutes or 5 cycles. After 2 minutes of CPR you will hear the following voice prompt:

- “Stop CPR.”

The AED will then return to Step 6 which is analyzing ECG and repeat this procedure. Ensure that no-one is in contact with the patient and proceed as before. This instruction will be lasted until emergency physician arrives and then hand over patient to emergency physician.

Note Performing CPR

When performing CPR watch and listen to the AED, the voice prompt “Begin CPR” will be emitted with flashing action icon at the rate of 100 times per minutes and beeping sound at the same rate of flashing action icon.

At least more than 2 inches (5cm) of compression depth and 100 ~ 120 beats per minutes of rate are the recommended compression depth and rate to perform compressions under AHA 2010 guidelines.

Note: Your Mediana dealer will have trained you in the particular SCA treatment protocol you have chosen. In all cases follow the voice prompts and visual instructions given by the AED.

Note User and Bystander Safety



WARNING: Make sure no one is touching the patient before you press the Shock button. Loudly announce, “Stand back! Do not touch the patient.” And look down the entire length of the patient to ensure there is no contact before pressing the Shock button.

Do not touch the patient while the AED is analyzing or delivering a shock is in process. Defibrillation energy can cause injury. As long as the AED is used according to the directions, and no one is in contact with the patient when the **Shock button** is pressed, there is no risk of harm to the rescuer or bystanders. The AED cannot deliver a shock unless the pads are applied to someone whose heart is in need of a shock.

Note: See warnings and cautions for more details.

MAINTENANCE



WARNING: Improper maintenance which is provided in this manual may damage the AED or cause it to function improperly. Maintain the AED according to directions.



WARNING: Do not let fluids to get into the AED. Avoid spilling any fluids on the AED or its accessories. Spilling fluids into the AED may damage it or cause a fire or electric shock hazard. Do not sterilize the AED or its accessories.



WARNING: Do not immerse any part of the AED in water or any type of fluid. Contact with fluids may seriously damage the AED or cause fire or electric shock hazard.



WARNING: Do not attempt to warm the electrodes with a heat source greater than 35° (95°).



WARNING: Do not clean the AED with abrasive materials, cleaners or solvents.



CAUTION: Follow local government ordinances and recycling instructions regarding disposal or recycling of AED components, including batteries.



CAUTION: Do not short-circuit the battery, as it may generate heat. To avoid short-circuiting, do not let the battery terminal come in contact with metal objects at any time, especially when transporting.



CAUTION: Do not solder the battery directly. Heat applied during soldering may damage the safety vent in the battery's positive cover.



CAUTION: Do not deform the battery by applying pressure. Do not throw, hit, drop, fold or impact the battery.



CAUTION: Do not use the battery with other maker's batteries, different types or models of batteries such as dry batteries, nickel-metal hydride batteries, or Li-ion batteries together, as they might leak electrolyte heat or explode.



CAUTION: Do not mistreat the battery, or use the battery in applications not recommended by Mediana.



CAUTION: Keep the battery out of reach of babies and children to avoid any accidents.



CAUTION: If there are any problems with the battery, immediately put the battery in a safe place and contact qualified service personnel or your local supplier.



CAUTION: Replacing new battery and placing the pads should carry out in environmental conditions described in this manual. If the AED is operated in out-of-range for environmental conditions, the AED can't be operated properly.

After using the AED, Mediana technical support recommend you perform the following actions:

1. Use the HeartOn AED Event Review Software to download information about the therapy performed and store appropriately. (If you do not have the HeartOn AED Event Review Software, please contact your dealer who can arrange for the incident to be downloaded)
2. Remove the used the pads from your AED and dispose of in a suitable manner. (For

-
- recommended disposal methods please refer to section the recycling and disposal)
3. Check the exterior of the AED for cracks or other signs of damage. Contact your distributor or Mediana technical support immediately if any damage is found.
 4. Check the exterior of the AED for dirt or contamination. If necessary, clean the AED with approved cleaning products.
 5. Check supplies, accessories and spares for damage or expiration. Replace immediately if any damage or expiration is found. Contact your local Mediana approved dealer.
 6. Install the new pads or battery. Before installing the new pads check that its use by date has not been exceeded.
 7. After installation of the new battery. Check the status Indicator. If the status Indicator is not displaying “O” refer to the troubleshooting section of this manual. If the problem persists, contact Mediana or your local approved dealer for technical support.
 8. Turn on the AED and verify that the AED operates in the correct manner i.e. voice prompt “Unit OK” can be heard. Turn off the AED.
 9. Contacting Mediana after use. At Mediana we like to hear from our customers whenever they have any occasion to use any of our products, even if therapy is not delivered as part of the incident. This information is vital to the continued development and constant improvement we strive for in the treatment of sudden.

Recycling and Disposal

When the AED, battery or accessories reach the end of useful life, recycle or dispose of the equipment according to appropriate local and regional regulations.

Note: The AED should be disposed of separately from the municipal waste stream via designated collection facilities appointed by the government or the local authorities.

Note: The correct disposal of your old appliance will help prevent potential negative consequences for the environment and human health.

Note: For more detailed information about disposal of your old appliance, please contact your city office, waste disposal service or the shop where you purchased the AED.

Returning the AED and System Components

To return the AED and/or accessories, contact qualified service personnel or your local supplier.

Service

The AED requires no routine service other than cleaning, battery maintenance, and service activity which is mandated by the user’s institution. For more information, refer to the AED service manual. Qualified service personnel in the user’s institution should perform periodic inspections of the AED. If service is necessary, contact qualified service personnel or your local supplier.

Periodic Safety Checks

It is recommended that the following checks be performed every year.

- Inspect the equipment for mechanical and functional damage.
- Inspect the external safety labels for legibility.

Cleaning

To clean the AED, wipe the AED with a soft cloth that has been dampened by one of the following:

- Soapy water.
- Isopropyl alcohol (70% solution).

For cables and pads, follow cleaning instructions in the directions for use shipped with those components.

Avoid spilling liquid on the AED, especially in connector areas. If liquid is accidentally spilled on the AED, clean and dry thoroughly before reuse. If in doubt about AED safety, refer the unit to qualified service personnel or your local supplier for checking.

Battery Maintenance

The new battery lifetime in use can be at least 10 hours monitoring or 200 shocks (excepting the CPR period between the defibrillation therapy) or a combination of both. The battery in the standby mode (inserted into the AED) has standby life (5 years from manufacture date). If the battery status is flashing one bar, you may need to replace the fresh battery. If the battery is not inserted into the AED, the battery has a shelf life. (2 years from manufacture date)

For diagnosis of the reason for status indicator display “X”, please refer to the troubleshooting section.

Pads Maintenance

Replacement of the pads must be carried out if:

- The use by date of the pads has been exceeded
- When the pads have been used (it is a single use item and must be replaced with new pads.)
- The package of new pads has been previously damaged
- The pads have been vent

Replacing Pads

1. Take the replacement pads from its protective bag.
2. Disconnect the pad connect from the AED.
3. Push the pads firmly to ensure it is fully inserted.
4. Turn on the AED.
5. Check the status indicator. If the pads have been inserted correctly, the status Indicator displays “O” after approximately 6 seconds.
6. If necessary inform relevant safety officer or person responsible for maintenance of the AED.
7. Update the relevant information to show the date that the replacement of pads and battery was placed into service.
8. Dispose of the old pads.

The AED Maintenance

Mediana recommends users perform regular maintenance checks. A suggested maintenance check would be.

1. Check the status Indicator. If the status Indicator displays “X”, a problem has been detected. Refer to the troubleshooting section of this manual.
2. Check the use by date of the pads. If the pads have exceeded its use by date, remove it and replace with the pads. Contact qualified service personnel or your local supplier for replacements.

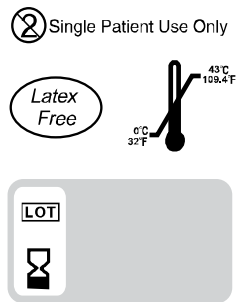

Figure 22. Use by date of Pads

3. Check the AED and accessories for damage or use by date. Replace any accessories found to be damaged or that have exceeded their use by date.
4. Check the exterior of the AED for cracks or other signs of damage. Contact qualified service personnel or your local supplier if any damage is found.
5. Check that trained user is aware of the AED location and that it is easily accessible for those Responders at all times.
6. Ensure all trained user have up to date training for both CPR and AED use. For recommended retraining intervals please consult the organization or body used to provide the Training.

TROUBLESHOOTING



WARNING: If you are uncertain about the accuracy of any measurement, check the patient's vital signs by alternate means; then make sure the AED is functioning correctly.



WARNING: To reduce the risk of electrical shock, do not attempt to remove the cover under any circumstances. There are no operator serviceable components and only a qualified technician should service the AED.

General

If the AED detects an error, it can display the "X" on the status indicator. Check the appropriate section or write down the description and contact qualified service personnel or your local supplier. Before calling to qualified service personnel or your local supplier, make sure it meets environmental conditions provided in the manual as temperature, humidity, altitude and so on.

Corrective Action

Check used by date the pads. Change the pads if use by date has been exceeded. Check shelf life or standby life of the battery. Change the battery if the shelf life or standby life has been exceeded.

Following is a list of possible errors and suggestions for corrective action.

If the status indicator is still not displaying "X" or a warning message is heard when the AED is turned on or if for any reason, you have suspicions that your AED is not working correctly contact qualified service personnel or your local supplier or Mediana directly for support. (info@mediana.co.kr)

1. There is no response to the opening the cover of the AED.

- A CPU module may be malfunctioned. Notify qualified service personnel or your local supplier to check and replace the CPU module.
- The battery may be missing or discharged. If the battery is missing, insert the battery (See Battery Operation section). If the battery is discharged, change the battery. (See Maintenance section)

2. The beep tones do not sound during the operation.

- Do not use the AED; contact qualified service personnel or your local supplier.

3. The beep tones sound but voice does not function properly.

- Reconnect the wire or replace the speaker.

4. The voice prompt "Plug in pads. Insert connector firmly".

- Reconnect the pad connector with pad socket firmly or replace the pad.

5. The action icon does not flash.

- Do not use the AED, contact qualified service personnel or your local supplier.

6. The voice prompt is unclearly heard.

- Do not use the AED, contact qualified service personnel or your local supplier.

7. The battery status does not indicate 3 bar despite of replacing new battery.

- If the battery status still not displayed 3 bar despite of replacing new battery, do not use the AED and contact qualified service personnel or your local supplier.

EMI (Electromagnetic Interference)



WARNING: Keep patients under close surveillance during delivering a shock. It is possible, although unlikely, that radiated electromagnetic signals from sources external to the patient and the AED can cause inaccurate measurement readings. Do not rely entirely on the AED readings for patient assessment.



WARNING: It is possible that any radio frequency transmitting equipment and other nearby sources of electrical noise may result in disruption in the AED operation.



WARNING: It is possible, although unlikely, that large equipment using a switching relay for its power on/off may affect the AED operation. Do not operate the AED in conjunction with electrocautery or diathermy equipment or in such environments.

This AED has been tested and found to comply with the limits for Medical devices to the IEC60601-1-2, and the Medical device Directive 93/42/EEC. These limits are designed to provide reasonable protection against harmful interference in a typical medical installation.

However, because of the proliferation of radio-frequency transmitting equipment and other sources of electrical noise in health care environments (such as electrosurgical equipment, cellular phones, mobile two-way radios, electrical appliances, and high-definition television), it is possible that high levels of such interference due to close proximity or strength of a source may affect AED operation.



WARNING: The AED is designed for use in environments in which the signal can be obscured by electromagnetic interference. During such interference, measurements may seem inappropriate or the AED may not seem to operate correctly.

The AED disruption may be indicated by erratic readings, cessation of operation, or other incorrect functioning. If this occurs, survey the site to determine the source of this disruption. Try the following actions to see if they eliminate the disruption:

- Turn equipment in the vicinity off and on to isolate the offending equipment.
- Reorient or relocate the interfering equipment.
- Increase the separation between the interfering equipment and this equipment.

The AED generates, uses, and can radiate radio frequency energy. If the AED is not installed and used in accordance with these instructions, the AED may cause harmful interference with other devices in the vicinity.

If assistance is required, contact qualified service personnel or your local supplier.

Obtaining Technical Assistance

For technical information and assistance, or to order the AED service manual, call your local supplier. The service manual provides information required by qualified service personnel or your local supplier when servicing the AED.

GLOSSARY

Sudden Cardiac Arrest (SCA)

Sudden cardiac arrest is a condition in which the heart suddenly stops pumping effectively due to a malfunction of the heart's electrical system. Often victims of SCA have no prior warning signs or symptoms. SCA can also occur in people with previously diagnosed heart conditions. Survival for an SCA victim depends on immediate cardio-pulmonary resuscitation (CPR). The use of an external defibrillator within the first few minutes of collapse can greatly improve the patients' chances of survival. Heart attack and SCA are not the same, though sometimes a heart attack can lead to a SCA. If you are experiencing symptoms of a heart attack (pain, pressure, shortness of breath, squeezing feeling in chest or elsewhere in the body) seek emergency medical attention immediately.

Heart Rhythm

The normal electrical rhythm by which the heart muscle contracts to create blood flow around the body is known as Sinus Rhythm. Ventricular Fibrillation (VF) caused by chaotic electrical signals in the heart is often the cause of SCA, but a shock can be administered to re-establish sinus rhythm. This treatment is called defibrillation. The AED is designed to automatically detect ventricular fibrillation (VF) and perform defibrillation on victims of sudden cardiac arrest.

Ventricular Tachycardia / Ventricular Fibrillation

Is a life-threatening heart rhythm that is treatable with the therapy using the AED.

Sinus Rhythm

Sinus Rhythm is the normal electrical rhythm by which the heart muscle contracts and expands to create blood flow around the body.

Biphasic Shock

A biphasic shock is an electrical current that is passed through the heart, firstly in one direction and then in another.

Biphasic Truncated Exponential (BTE) waveform

Biphasic Truncated Exponential (BTE) waveform stands for Self-Compensating Output Pulse Envelope Waveform.

Pads

Pads are the electrodes that are connected to the patient's chest in order to administer therapy.

Electromagnetic Interference

Electromagnetic interference is radio interference that may cause erroneous operation of electronic equipment.

Impedance Measurement

Impedance measurement is a check that is performed to check the integrity of AED patient contact.

Detecting Fibrillation

The electrical rhythm by which the heart muscle contracts can be detected and used for medical diagnosis and the resulting reading is called an Electrocardiogram (ECG). The AED has been designed to analyze a patient's ECG in order to detect ventricular fibrillation (VF) in the heart. If ventricular fibrillation (VF) is detected the AED will deliver a carefully engineered electrical shock designed to stop the chaotic electrical activity experienced within the heart muscle during SCA. This may allow the victim's heart to return to a sinus rhythm.

HeartOn A15®

The AED is a semi-automatic device used for the delivery of external defibrillation therapy to resuscitate victims of SCA, who are unresponsive, are not breathing, or without life signs.

HeartOn AED Event Review Software

HeartOn AED Event Review Software is software that can be used in conjunction with the AED and SD card (or Infrared communication cable). It can retrieve and view information about therapy delivered using the AED. Also, HeartOn AED Event Review Software can be used to configure the AED.

More Information

If you have had any occasion to use your AED or if you require any further information on the AED, its accessories or any other products please contact us.

SPECIFICATION

Defibrillation Electric Shock

Waveform	Biphasic Truncated Exponential (BTE) waveform (impedance compensation)
Energy	Adult: 185 to 200J ($\pm 5\%$) Pediatric: 45 to 50J ($\pm 5\%$)
Operating mode	Semi-Auto

ECG

Lead	II (RA, LL)
Patient impedance	25 to 175 ohm
Heart Rate	20 to 300 per min
Accuracy	1 per min
Detection	V/F more than 200 μ V V/T more than 160 per min
Lead connection	Confirm the connection and emit voice prompt
Filter	0.5 to 30 Hz

Indication

Controls	
Standard	Slide button, Shock button, Patient mode switch
Indicators	
Visible	ICON Indicator, Status LCD(Unit status, Battery status, Temperature status), LED (Patient mode switch LED)
Audible	Audio speaker (Voice prompt), Beep (CPR indication)

Physical

Dimensions	240 × 294 × 95 (mm) (W×H×D)
Weight	Approx. 2.65 kg including the battery excluding pads

Environmental Conditions

Operation	
Temperature	0 to 43°C (32 to 109.4°F)
Relative Humidity	5 to 95% RH (Non-condensing)
Altitude	0 to 4,575 m
Shock	Acceleration: 100 G (+/- 10%) Time: 6 msec The number of shocks: 3 times/axis (6 axes (+/- X, Y, Z))
Vibration	Frequency: 10Hz to 2000Hz Acceleration : 10 Hz to 100 Hz: 5,0 (m/s ²)/Hz 100 Hz to 200 Hz: -7 dB per octave 200 Hz to 2000 Hz: 1,0 (m/s ²)/Hz
Drop height	1m
Water and dust resistance	IP54 (IEC60529)
Storage (in shipping container)	
Temperature	-20 to 60°C (-4 to 140°F)
Relative Humidity	5 to 95% RH (Non-condensing)
Altitude	0 to 12,192 m

Self Test

Cycle	Every 24 hours, 1 week, 1 month Power on self test, Battery insertion self test
Test result	Status LCD displays "O"/ "X".

Data Backup and Communication

Standard	SD card, Infrared communication port
----------	--------------------------------------

Accessories Specifications

Pads

Adult / Pediatric Pads	
Standby life	2 years from manufacture date
Electrodes	Disposable pads
Placement	Adult: Anterior-lateral Pediatric: Anterior-posterior
Minimum active gel area	80 cm ² +/-5%
Cable length	About 1.8 m
Environmental Conditions	
Temperature	Operation: 0 to 43°C (32 to 109.4°F)
	Storage: 0 to 43°C (32 to 109.4°F)
Relative Humidity	5 to 95% RH (Non-condensing)

Battery

Battery	
Type	LiMnO ₂ , Disposable, Long-Life Primary Cell
Voltage/Capacity	15V, 4200 mAh
Shelf Life (in the original packaging)	2 years from manufacture date
Standby Life (inserted in the AED)	5 years from manufacture date
Discharge	A minimum of 200 shocks (excepting the CPR period between the defibrillation therapy) or 10 hours of operating time at 20°C
Environmental Conditions	
Temperature	Operation: 0 to 43°C (32 to 109.4°F)
	Storage: 0 to 43°C (32 to 109.4°F)
Relative Humidity	5 to 95% RH (Non-condensing)

Defibrillation waveform

Defibrillation waveform

Waveform parameters

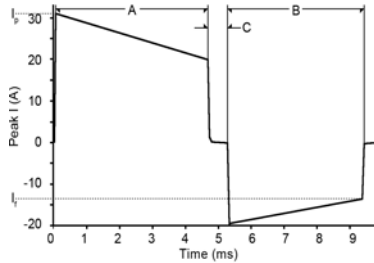

Waveform parameters are automatically adjusted as a function of patient defibrillation impedance. In the diagram at left, A is the width of pulse 1 and B is the width of pulse 2 of the waveform, C is the inter-pulse delay, I_p is the peak current, and I_f the final current.

The AED delivers shocks to load impedances from 25 to 175 ohms. The duration of each pulse of the waveform is dynamically adjusted based on delivered charge, in order to compensate for patient impedance variations, as shown below:

Adult defibrillation

Load Resistance (Ω)	Pulse width 1 (ms)	Pulse width 2 (ms)	Delivered Energy (J)
25	3.3	3.1	195
50	4.7	4.1	190
75	6.7	4.7	185
100	8.3	5.9	195
125	9.7	6.7	190
150	11.3	7.9	185
175	11.7	8.7	180

Pediatric defibrillation

Load Resistance (Ω)	Pulse width 1 (ms)	Pulse width 2 (ms)	Delivered Energy (J)
25	3.3	3.1	51
50	4.7	4.1	50
75	6.7	4.7	49
100	8.3	5.9	51
125	9.7	6.7	50
150	11.3	7.9	49
175	11.7	8.7	47

Charge control	Controlled by patient analysis system for automated operation.
Charging Time	< 12 seconds typical
Shock Analysis Time	< 13 seconds typical

ECG Analysis Performance

Rhythm class	ECG analysis performance
Shockable rhythm, Ventricular Fibrillation	Complies with IEC60601-2-4:2010 (sensitivity > 90%)
Shockable rhythm, Ventricular Tachycardia	Complies with IEC60601-2-4:2010 (sensitivity > 75%)
Non-Shockable rhythm	Complies with IEC60601-2-4:2010 (specificity > 95%)

Database for ECG Analysis

- From AHA (American Heart Association) official database
- From MIT (Massachusetts institute Technology) official database (MIT-BIH Arrhythmia Database and Creighton University Ventricular Tachyarrhythmia Database)

ECG rhythm to determine if a shock is appropriate

- Ventricular Fibrillation at a amplitude greater than or equal to 0.2mV
- Ventricular Tachycardia at a heart rate greater than or equal to 160 bpm

Compliance

Item	Standard	Description
Classification	IEC 60601-1:2005 +A1:2012 EN 60601-1:2006/ AC2010	Internally powered (on battery power)
Type of protection	IEC 60601-1:2005 +A1:2012 EN 60601-1:2006/ AC2010	Type CF – Applied part
Mode of operation	IEC 60601-1:2005 +A1:2012 EN 60601-1:2006/ AC2010	Continuous
Degree of protection	IEC 60529:2001, EN 60529:1991+A1 2000	IP54 (provided by enclosures)
General	93/42/EEC as amended by 2007/47/EC	Medical device Directive (class IIb)
	21CFR820	Code of federal regulations
	2012/19/EU	Waste Electrical and Electronic Equipment
	93/86/EEC	Battery disposal directive
	2006/66/EC as amended by 2008/103/EC	Battery directive
	ISO 13485:2003 EN ISO 13485:2003	Quality systems - Medical devices - Requirements for regulating purposes
	ISO 14971:2007 EN ISO 14971:2012	Application of risk management to Medical devices
	IEC 60601-1:2005 +A1:2012 EN 60601-1:2006/ AC2010	General requirements for safety of medical electrical equipment
	IEC 60529:2001 EN 60529:1991+A1:2000	Degree of Protection Provided by Enclosures Water Ingress Testing (IP54)
	ISO 14155:2011 EN ISO 14155:2011	Clinical investigation of Medical devices for human subjects – part 1: General requirements
	AAMI HE75:2009	Human factors engineering guidelines and preferred practices for the design of Medical devices
	IEC 62304:2006 EN 62304:2006	Medical device software - Software life-cycle processes
	IEC 60601-1-6:2010 EN 60601-1-6:2010	Medical electrical equipment - Part 1-6: General requirements for basic safety and essential performance - Collateral standard: Usability
	IEC 62366:2007 EN 62366:2008	Medical devices - Application of usability engineering to Medical devices
	IEC 60601-1-9:2007 EN 60601-1-9:2008	Medical electrical equipment - Part 1-9: General requirements for basic safety and essential performance - Collateral Standard: Requirements for environmentally conscious design
	ISO 10993-1:2009/Cor1:2010 EN ISO 10993-1:2009/AC1: 2010	Biological evaluation of Medical devices – Part 1: Evaluation and testing
	ISO 10993-5:2009 EN ISO 10993-5:2009	Biological evaluation of Medical devices – Part 5: Tests for in vitro cytotoxicity
	ISO 10993-10:2010 EN ISO 10993-10:2010	Biological evaluation of Medical devices – Part 10: Tests for irritation and delayed-type hypersensitivity
Ambulance	EN 1789:2007 +A1:2010	Medical vehicles and their equipment

Item	Standard	Description
		– road ambulance
	EN 13718-1:2008	Medical vehicles and their equipment - Air ambulances - Part1:Requirements for medical devices used in air ambulances
	RTCA/DO-160G	Environmental Conditions and Test Procedures for Airborne Equipment
Defibrillator	IEC 60601-2-4:2010 EN 60601-2-4:2011	Safety of cardiac defibrillators
	AAMI EC57:1998(R)2008	Testing and reporting performance results of cardiac rhythm and ST-segment measurement algorithms
EMC	IEC 60601-1-2:2007 EN 60601-1-2:2007	Electromagnetic compatibility-requirements & test
	IEC 61000-4-2:2008 EN 61000-4-2:2009	Electrostatic discharge (ESD) Ed.2.0
	IEC 61000-4-3:2006 +A1:2008+A2:2010 EN 61000-4-3:+A1:2008 +A2:2010	Radiated RF electromagnetic field Ed.3.2
	IEC 61000-4-8:2009 EN 61000-4-8:2010	Power frequency (50/60Hz) Magnetic field Ed.2.0
	CISPR 11:2009+A1:2010 EN 55011:2009+A1:2010	Limits and methods of measurement of radio disturbance characteristics of industrial scientific and medical (ISM) radio-frequency equipment RF emissions, Group 1, Class B
Package	ISTA (Procedure 1A, 2001)	Pre-Shipment test procedures (Package)
Reliability	IEC 60068-1:1988+A1:1992 EN 60068-1:1994	Environmental testing, Part1: General guidelines
	IEC 60068-2-1:2007 EN 60068-2-1:2007	Environmental testing - Part 2-1: Tests - Test A: Cold
	IEC 60068-2-2:2007 EN 60068-2-2:2007	Environmental testing - Part 2-2: Tests - Test B: Dry heat
	IEC 60068-2-30:2005 EN 60068-2-30:2005	Environmental testing - Part 2-30: Tests - Test Db: Damp heat, cyclic (12 h + 12 h cycle)
	IEC 60068-2-27:2008 EN 60068-2-27:2009	Environmental testing – Shock
	IEC 60068-2-6:2007 EN 60068-2-6:2008	Environmental testing – Vibration
	IEC 60068-2-64:2008 EN 60068-2-64:2008	Environmental testing: vibration, broad-band random (digital control) and guidance
Labeling	EN 1041:2008	Information supplied by the manufacturer with Medical devices
Marking	IEC /TR 60878:2003	Graphical symbols for electrical equipment in medical practice
	ISO 15223-1:2011	Symbols to be used with medical device labels, labelling and information to be supplied -- Part1: General requirements
	ISO 15223-2:2010	Symbols to be used with medical device labels, labelling, and information to be supplied -- Part2: Symbol development, selection and validation

Item	Standard	Description
	ISO 7000:2012	Graphical symbols for use on equipment-index and synopsis
	EN 50419:2006	Marking of electrical and electronic equipment in accordance with article II (2) of directive 2002/96/EC (WEEE)

Manufacturer's Declaration



WARNING: For best product performance and measurement accuracy, use only accessories supplied or recommended by Mediana. Use accessories according to the manufacturer's directions for use and your facility's standards. The use of accessories, transducers, and cables other than those specified may result in increased emission and/or decreased immunity of the AED.

The AED is suitable for use in the specified electromagnetic environment. The customer and/or user of the AED should assure that it is used in an electromagnetic environment as described below;

Table 5. Electromagnetic Emissions (IEC60601-1-2)

Emission Test	Compliance	Electromagnetic Environment
RF emission CISPR 11	Group 1	The AED must emit electromagnetic energy in order to perform its intended function. Nearby electronic equipment may be affected.
RF emissions CISPR 11	Class B	The AED is suitable for use in all establishments.

Table 6. Electromagnetic Immunity (IEC60601-1-2)

Immunity Test	IEC60601-1-2 Test Level	Compliance Level	Electromagnetic Environment Guidance
Electrostatic discharge (ESD) IEC 61000-4-2	±6 kV contact ±8 kV air	±6 kV contact ±8 kV air	Floor should be wood, concrete, or ceramic tile. If floors are covered with synthetic material, the relative humidity should be at least 30 %.
Power frequency (50 Hz) magnetic field IEC 61000-4-8	3 A/m	80 A/m	It may be necessary to position the AED further from the sources of power frequency magnetic fields or to install magnetic shielding. The power frequency magnetic field should be measured in the intended installation location to assure that it is sufficiently low.

Note: UT is the AC mains voltage prior to application of the test level.

Table 7. Electromagnetic Immunity (IEC60601-1-2) (continued)

Immunity Test	IEC60601 test level	Compliance Level	Electromagnetic environment guidance
The AED is intended for use in the electromagnetic environment specified below. The customer or the user of the AED should assure that it is used in such an environment.			
Radiated RF IEC 61000-4-3	3V/m, 10 V/m, 20 V/m 80 MHz ~ 1 GHz 1 GHz~ 2.5 GHz (These values are set in accordance with IEC60601-2-4)	10 V/m, 20V/m	<p>Potable and mobile RF communications equipment should be used no closer to any part of the AED including cables, than the recommended separation distance calculated from the equation appropriate to the frequency of the transmitter.</p> <p>Recommend separation distance $d = 1.2 \sqrt{P}$ 80 MHz to 800 MHz $d = 2.3 \sqrt{P}$ 800 MHz to 2.5 GHz</p> <p>Where P is the maximum output power rating of the transmitter in watts (W) according to the transmitter manufacturer and d is the recommended separation distance in metres (m).</p> <p>Field strengths from fixed RF transmitters as determined by an electromagnetic site survey,^a should be less than the compliance level in each frequency range.^b</p> <p>Interference may occur in the vicinity of equipment marked with the following symbol:</p> 
<p>Note: At 80 MHz and 800 MHz, the higher frequency range applies. Note: These guidelines may not apply in all situations. Electromagnetic propagation is affected by absorption and reflection from structures, objects, and people.</p>			
<p>^a Field strengths from fixed transmitters, such as base stations for radio (cellular/ cordless) telephones and land mobile radio, AM and FM radio broadcast, and TV broadcast cannot be predicted theoretically with accuracy. To assess the electromagnetic environment due to fixed RF transmitters, an electromagnetic site survey should be considered. If the measured field strength in the location in which the AED is used exceeds the applicable RF compliance level above, the AED should be observed to verify normal operation. If abnormal performance is observed, additional measures may be necessary, such as re-orienting or relocating the AED.</p> <p>^b Over the frequency range 80 MHz to 2.5 GHz, field strengths should be less than 10 V/m</p>			

Recommended Separation Distances between Portable and Mobile RF Communications Equipment and the AED. (IEC60601-1-2)

Table 8. Recommended Separation Distances

Recommended separation distance between Portable and mobile RF communications equipment and the AED		
<p>The AED is intended for use in an electromagnetic environment in which radiated RF disturbances are controlled. The customer or the user of the AED can help prevent electromagnetic interference by maintaining a minimum distance between portable and mobile RF communications equipment (transmitters) and the AED as recommended below, according to the maximum output power of the communications equipment.</p>		
Rated Maximum Output Power of Transmitter in watt	Separation distance according to frequency of transmitter in meter	
	80 MHz to 800 MHz $d = 1.2 \sqrt{P}$	800 MHz to 2.5GHz $d = 2.3 \sqrt{P}$
0.01	0.12	0.23
0.1	0.38	0.73
1	1.2	2.3
10	3.8	7.3
100	12	23
<p>For transmitters rated at a maximum output power not listed above, the recommended separation distance d in metres (m) can be estimated using the equation applicable to the frequency of the transmitter, where P is the maximum output power rating of the transmitter in watts (W) according to the transmitter manufacturer.</p> <p>Note: At 80MHz and 800MHz, the separation distance for the higher frequency range applies</p> <p>Note: These guidelines may not apply in all situations. Electromagnetic propagation is affected by absorption and reflection from structures, objects, and people.</p>		

Table 9. Cables (IEC60601-1-2)

Cables and Sensors	Maximum Length	Complies with
Pads cable	1.8 m	<ul style="list-style-type: none"> -RF emissions, CISPR 11, Class B/ Group 1 -Electrostatic discharge (ESD), IEC 61000-4-2 -Radiated RF, IEC 61000-4-3 -Power frequency Magnetic field, IEC 61000-4-8